

NO_x RECLAIM WORKING GROUP MEETING

APRIL 12, 2018
SCAQMD
DIAMOND BAR, CA

Agenda

- Rule Updates
 - PAR 1146 Series/PR 1100
 - PR 1118.1
 - PAR 1134
 - PAR 1135
 - PR 1109.1
- New Source Review for RECLAIM Transition Discussion
- Initial Determination Notifications
- Subsequent Amendments to Rule 2001/2002
- Presentation by Engineering and Permitting

UPDATE ON PROPOSED RULES AND PROPOSED AMENDED RULES

3

Upcoming Working Group Meetings

Proposed Amended Rules
1146, 1146.1, 1146.2, and
Proposed Rule 1100

- Fourth Working Group Meeting
April 12, 2018
1:30 PM
Conference Room GB

Proposed Amended Rule
1134

- Second Working Group Meeting
April 26, 2018
9 AM
Conference Room GB

Proposed Amended Rule
1135

- Second Working Group Meeting
April 26, 2018
1:30 PM
Conference Room GB

4

Proposed Amended Rule 1146 Series Update

- Rule 1146 Series rules – the first set of landing rules to be amended
- Key amendments
 - Remove RECLAIM exemptions
 - Maintain existing NOx concentration limits in all three rules
 - Exempt RECLAIM facilities from compliance dates in existing rules
 - Reference Proposed Rule 1100 for implementation schedule for Rules 1146 and 1146.1
 - New equipment needs to meet Rule 1146.2 NOx concentration limits
 - Existing equipment needs to meet Rule 1146.2 NOx concentration limit unless technology assessment recommends different emission limit

5

Proposed Amended Rule 1146 Series Implementation Schedule – Proposed Rule 1100

- Implementation schedule would apply to all Rule 1146 and 1146.1 applicable devices
- Proposed implementation schedule in PR 1100:
 - 75% of units by heat input for Rule 1146 and 1146.1 units (excluding BARCT-compliant equipment) by Jan. 1, 2021;
 - 100% of units by heat input by Jan 1, 2022
- Public Workshop held on February 14, 2018
- CEQA Draft Subsequent Environmental Assessment made available on April 3, 2018
 - Revised draft rule language also made available

6

PR 1109.1 – Refinery Equipment

- First PR 1109.1 Working Group Meeting held on February 21st
- Draft survey for BARCT assessment distributed on March 16, 2018
 - Staff is addressing stakeholder comments
 - Upon completion, staff will pre-populate and distribute to affected facilities
- Working Group Meeting #2 will be held in late April/early May
- Staff is continuing to assess data
- Public Hearing currently scheduled for December 2018

7

PR 1118.1 – Control of Emissions from Non-Refinery Flares

- Affected universe includes approximately 140 facilities, 5 from RECLAIM (process flares)
- Released preliminary draft rule language on March 4, 2018
 - Proposing flare replacement after 20 years to meet emission limits, or demonstrate specific percent of waste gas is used beneficially
- 5th Working Group Meeting held on April 4, 2018
- Continuing discussions with stakeholders
- Public Hearing currently scheduled for July 2018

8

PAR 1134 – Emissions of Oxides of Nitrogen from Stationary Gas Turbines

- First PAR 1134 Working Group Meeting held on February 22, 2018
- Second Working Group Meeting scheduled April 26th and will discuss
 - Emission Inventories
 - Initial BARCT assessments
 - Rule concepts
- Public Hearing currently scheduled for October 2018

9

PAR 1135 – Emissions of Oxides of Nitrogen from Electric Power Generating Systems

- First PAR 1135 Working Group Meeting held on January 24, 2018
- Second Working Group Meeting scheduled April 26th and will discuss
 - Emission Inventories
 - Initial BARCT assessments
 - Rule concepts
- Public Hearing currently scheduled for November 2018

10

NEW SOURCE REVIEW – POSSIBLE PATHWAYS

11

New Source Review for RECLAIM Transition - Background

- The Draft Transition Plan outlines general comparisons of New Source Review requirements for RECLAIM and non-RECLAIM (Table 3)
 - RECLAIM – Rule 2005
 - Non-RECLAIM – Regulation XIII
- Both programs are SIP-approved

12

Guiding Principles for New Source Review Requirements for Transitioning RECLAIM Facilities

- Ensure that emission increases from new and modified sources do not interfere with efforts to attain and maintain State and Federal air quality standards
- No backsliding from current State And Federal NSR requirements
- Allow for future economic growth and facility modernization at RECLAIM facilities
- Provide the most streamlined approach for both SCAQMD and affected facilities

13

New Source Review for RECLAIM Transition - Background

- New Source Review emission increases are based on Permit to Emit (PTE) and are when:

Post-modification PTE > Pre-modification PTE

| Provision | RECLAIM | Non-RECLAIM |
|----------------------------------------------------------------------------------------------------|-------------------------------------------------------------------------------------------------------------------------------------------------------------------------------------------------------------------------------|-----------------------------------------------------------------------------------------------------------------------------------------------------|
| Offset, BACT, and Modeling, etc. For example: Offsetting Requirements for Emission Increases | <ul style="list-style-type: none"> • RTCs must be held to offset PTE at the beginning of each compliance year; AND • Reconciled against the <u>actual emissions</u> at the end of the compliance year | ERCs are required to offset PTE at the time of permitting and are valid in perpetuity* <small>*with the exception of Short-Term ERCs</small> |
| Time period for determining PTE | Hourly (lb/hr) | 30-Day average (lb/day) |

Offsets for RECLAIM and Non-RECLAIM

- Sources for Obtaining/Purchasing Offsetting Credits
 - RECLAIM: RTCs can be purchased from the RECLAIM market, which for the past few years has exceeded 4.5 tons per day of NOx RTCs in excess of total NOx emissions from RECLAIM facilities*
 - Can be purchased in discrete year or infinite block streams
 - Non-RECLAIM:
 - ERCs purchased in the open market - approximately 0.5 tons per day for NOx supply
 - Access to SCAQMD's Priority Reserve, for facilities such as essential public services
 - Access to SCAQMD's "Internal Bank" for sources exempt from offsetting under Rule 1304 (e.g., below 4 tons per year of NOx PTE)

*BARCT shaves taken into account

15

Comparison Between RECLAIM and Non-RECLAIM Offsetting Requirements

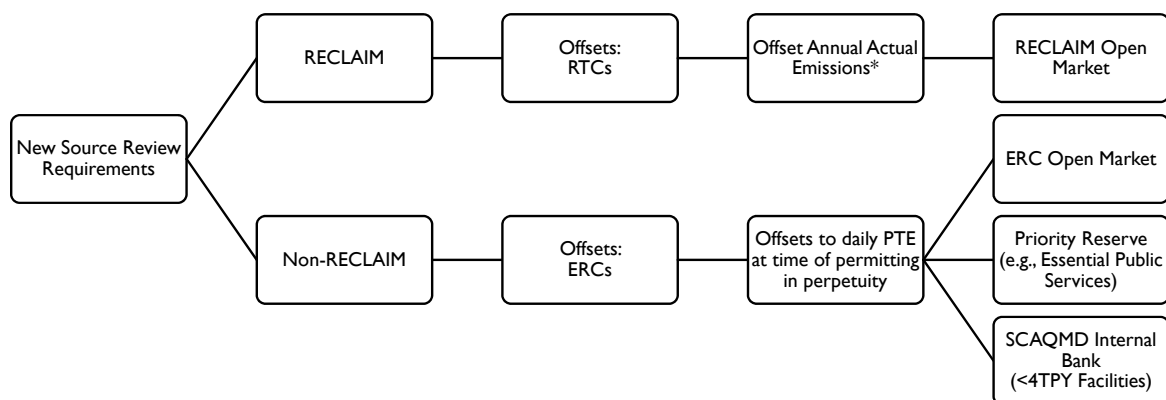

* New facilities must hold RTCs to PTE at the beginning of each compliance cycle.

16

Source of Offsets in SCAQMD's Internal Bank

- Offsets must meet the requirements that they are real, permanent, enforceable, quantifiable, and surplus
- SCAQMD's internal bank is funded with offsets that were determined as valid for the beginning balance
 - Ongoing sources of offsets are due to shutdowns from both major and minor sources
- In recent years, orphan shutdowns have been the primary source of offsets for the internal bank
 - Orphan shutdowns are emissions from sources that shut down but did not apply for ERCs
 - Other sources, to a lesser extent, may include any creditable major and minor source ERC use, such as surplus emission reductions and use of ERCs as emission offsets beyond Federal NSR offset requirements

17

Possible Pathways for New Source Review Offsets for Former RECLAIM Facilities

- Identified four possible pathways for offsetting requirements under New Source Review for facilities that transition out of RECLAIM
- Both RECLAIM and non-RECLAIM require BACT and modeling – pathways will focus on offsetting requirements and source of offsets
- Objective
 - Discuss how possible offsetting pathways could be implemented after facilities transition out of RECLAIM
 - Understand the considerations for each pathway
 - Help the decision-making process
- There are additional pathways and hybrid approaches

18

Potential Demand and Estimated Supply

- Estimated demand for new and modified sources
 - Additional analysis needed for an estimation of new projects amidst ongoing emission reduction projects
- Estimated supply for:
 - RTCs:
 - 4.5 tons per day for Compliance Year 2016
 - This quantity may reduce due to the ongoing shave up until 2022
 - ERCs:
 - ERC open market: 0.5 tons per day
 - SCAQMD Internal Bank: 2015 Ending Balance = 24.5 tons per day
Limited by Rule 1315 Table B (0.84 tpd of NOx for 2019)

19

Four Possible Pathways Evaluated

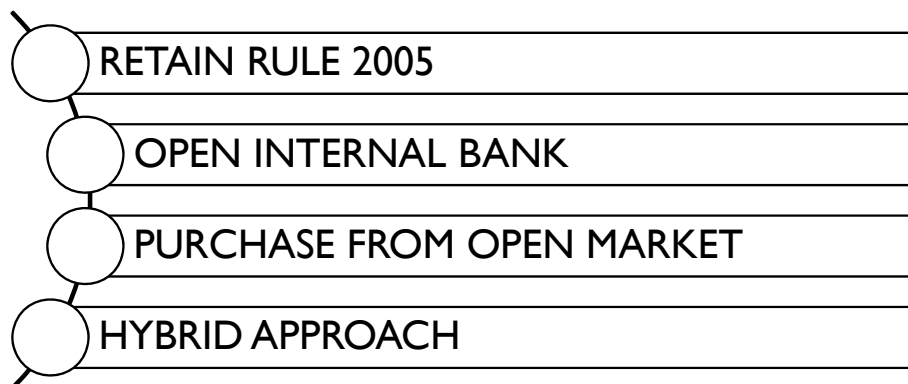

20



RETAIN RULE 2005

- **Description of Scenario**
 - Former RECLAIM facilities would be subject to the offsetting provisions of R2005 for NSR
 - Require to hold RTCs to their PTE each year
 - Offset to actual emissions annually
 - Establish a temporary account of RTCs for the purposes of NSR offsetting
 - Generation of RTCs would be based on shutdowns – no BACT discounting
- **Initial analysis and considerations**
 - Offsetting requirements would be different for RECLAIM and non-RECLAIM sources
 - Current offsetting requirements are different for RECLAIM and non-RECLAIM facilities ²¹



RETAIN RULE 2005 *(Continued)*

- **Initial analysis and considerations *(Continued)***
 - Need to determine the amount of RTCs that could be used for NSR
 - Offsetting to actual emissions
 - Will reduce the demand for RTCs
 - Requires same level of monitoring under RECLAIM
 - If SCAQMD maintains “RTC bank”, will it be accessible to all former RECLAIM facilities
 - Considerations for limitations on access – amount of RTCs, project type, etc.
 - Need to establish fee for use of RTC

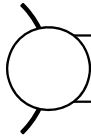

OPEN INTERNAL BANK

- Description of Scenario
 - Former RECLAIM facilities would provide offsets pursuant to Regulation XIII – at time of permit to permitted level (PTE)
 - SCAQMD internal bank would be made available for former RECLAIM facilities that require offsets for emission increases
 - Access to the internal bank temporary to allow generation of ERCs in the Open Market

23



OPEN INTERNAL BANK *(Continued)*

- Initial analysis and considerations
 - Supply could potentially expected to meet the demand (further analysis required)
 - CEQA backstop provisions in R1315 could potentially be triggered if cumulative net emission increase thresholds are exceeded – concern for permit moratorium of threshold exceeded
 - Additional analysis needed
 - Considerations for limitations on access – amount of ERCs, project type, etc.
 - Need to ensure adequate supply for facilities < 4 tons per year

24

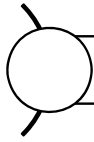

PURCHASE FROM OPEN MARKET

- Description of Scenario
 - Offsets for emission increases would be obtained from the open ERC market
- Initial analysis and considerations
 - Current supply of NOx ERCs in the open market is 0.5 tons per day
 - Not all ERCs are available – ERC holders may not want to sell ERCs
 - Demand may exceed the supply of ERCs in the open market
 - Insufficient supply of ERCs may inhibit a facility's ability to grow or modernize

25

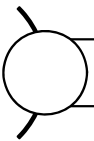

HYBRID APPROACH

- Description of Scenario
 - Retain R2005 BACT and offset provisions until NSR is triggered in the future
 - Regulation XIII requirements upon subsequent modifications
- Initial analysis and considerations
 - Convert annual year-to-year RTC holding requirements to hourly emission limits
 - Establish a mechanism to determine pre-modification baseline emissions utilizing R2005 methodology (further details explained later in the presentation from Engineering and Permitting)

26

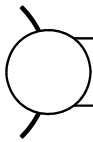

HYBRID APPROACH, continued

- Initial analysis and considerations (*Continued*)
 - A portion of the surplus IYB RTCs can be retained to fund a temporary account within the SCAQMD internal bank for offsetting emission increases
 - This time period could allow for a replenishment supply of ERCs to be generated from former RECLAIM facilities
 - The current NSR program will require updating to track the use of credits from this new account under the SCAQMD internal bank

27

Update on Initial Determination Notifications

- First set of Initial Determination Notifications sent Feb. 2, 2018
 - Sent to 37 facilities by certified mail
 - All facilities have provided responses
 - 9 facility submissions are incomplete
 - Subsequent notifications to be sent out requesting the complete information

28

Subsequent Amendments to Rule 2001/2002

- Opt-out provisions
 - Will address facilities that should have been identified with the first group of facilities for potential exit or facilities that have modified and are in compliance with the amended landing rules (e.g., R1146) and are ready to exit
 - A RECLAIM facility would notify the Executive Officer if it meets certain specified criteria (e.g., no RECLAIM equipment on site as well as being reflected on the most recent permit, or in compliance with all applicable amended landing rules)
 - Facilities meeting the criteria would then be eligible to receive an initial determination notification

29

Subsequent Amendments to Rule 2001/2002

- Facilities subject to compliance plans
 - For facilities in unique situations that cannot be addressed in command-and-control or industry-specific rules
 - Details of compliance plan will be addressed at next Working Group Meeting
- Initially scheduled for the September 2018 public hearing

30

PERMITTING FOR THE RECLAIM TRANSITION

PRESENTATION BY ENGINEERING & PERMITTING

31

Permitting – Guiding Principles

“Keep an Open Mind”

Identify the most streamlined/least resource intensive pathway

Minimize impact on application backlog

Comply with all applicable regulations

Minimize cost impacts

Seek an expeditious and smooth transition

32

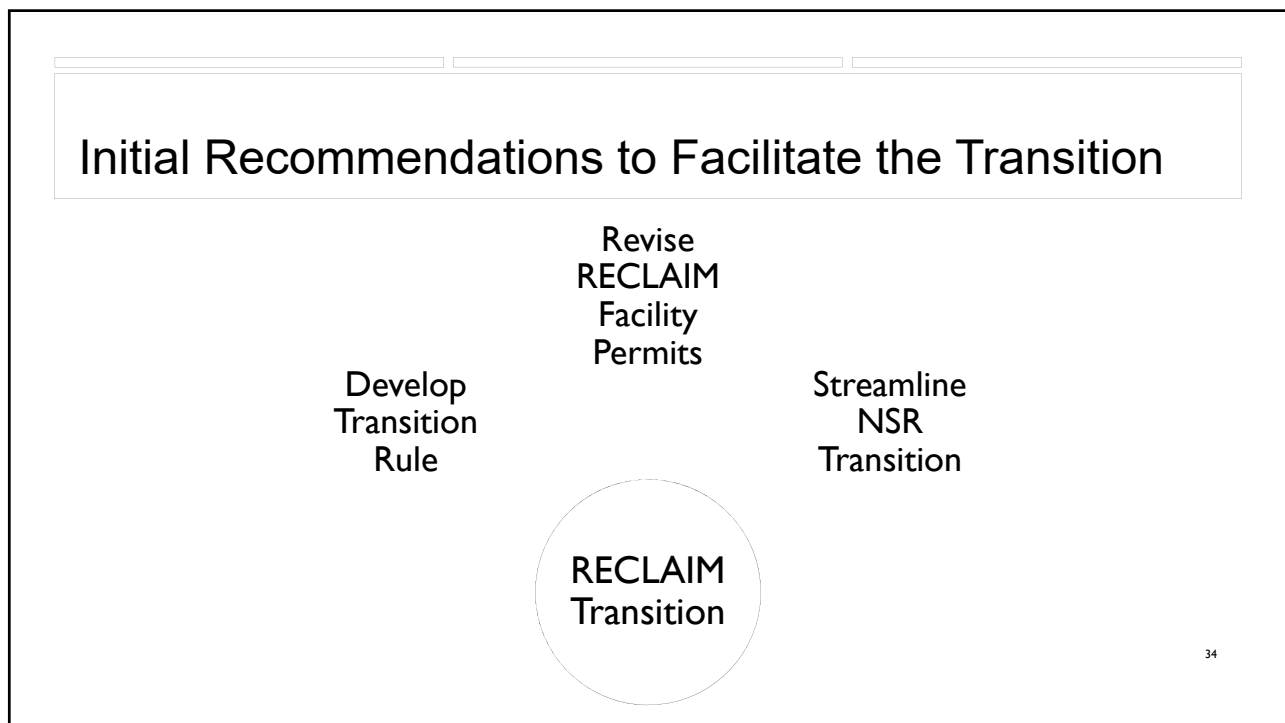
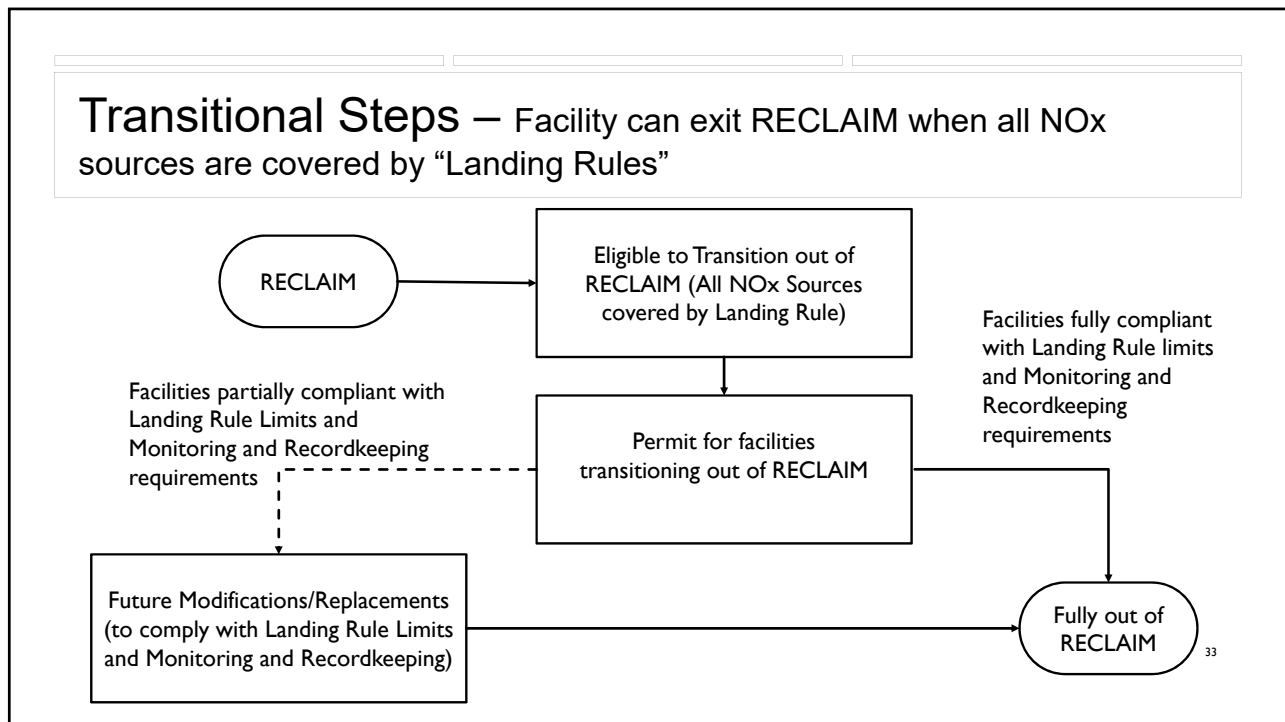

Develop Transition Provisions

- Transition provisions can be incorporated in a rule that will help guide the RECLAIM facility permit revision process and will include provisions to help minimize permit revisions
- Suggested key elements
 - Specify RECLAIM requirements that are no longer applicable when a facility transitions out of RECLAIM (e.g. Emission Reconciliation, Reporting, etc.)
 - Specify provisions (i.e. RECLAIM limits, Monitoring, and Recordkeeping) that are applicable until equipment complies with all Landing Rule limits, Monitoring, and Recordkeeping requirements
 - Retain RECLAIM New Source Review (NSR) based limits and conditions until next event triggering Reg. XIII (RECLAIM transition is not an NSR event)
 - Compliance with Landing Rule requirements may be demonstrated by existing performance tests or new tests ³⁵

Revise RECLAIM Facility Permits

- Keep “facility permit” format instead of “equipment-specific” permit format
- Remove, as necessary, references to RECLAIM provisions
- Reflect Landing Rule provisions upon compliance

Revise RECLAIM Facility Permits (continued)

- Permit for Facility Transitioning out of RECLAIM to Include:
 - Overriding condition to “negate” any existing RECLAIM limits or conditions that are exempted by rule
 - For NOx sources already meeting all applicable Landing Rule (LR) limits and Monitoring and Recordkeeping (MR) requirements:
 - ✓ Replace RECLAIM limits/conditions with LR limits and MR requirements;
 - ✓ Reflect compliance demonstration/source test requirements
 - Alternative method of complying with NSR hold requirements (discussed in later slide)
 - Removal or replacement of Rule 219 exempt equipment, as appropriate
 - No changes to RECLAIM requirements for NOx sources not fully compliant with LR limits and MR requirements

37

Revise RECLAIM Facility Permits (continued)

- Future Equipment Modifications
 - Normal permit process for modifications or replacements
 - Replacement of RECLAIM with Landing Rule limits and Monitoring and Recordkeeping requirements
 - Compliance demonstration through source tests
 - Removal or replacement of Rule 219 exempt equipment (e.g. Rule 1146.2 or 1470 equipment)

38

Revise RECLAIM Facility Permits (continued)

- Title V Permit Issuance Process
 - Specify, as part of the transition rule, that permit revisions for purely transitioning out of RECLAIM qualifies as a “Minor” Permit Revision
 - ✓ Transition from one regulatory structure to an equivalent one does not increase emissions or relax MRR requirements
 - However, modification of limits or monitoring requirements as a result of modifications to equipment or processes may be a “Significant” Permit Revision
 - EPA review and public process apply as defined by type of permit revision

39

Streamlining NSR Transition

- Retain existing NSR limits/conditions until next NSR triggering event
- Convert year-to-year RTC hold requirements (lbs/yr) to hourly emission limits or equivalent process rate limits based on original calculations
- For future modifications, establish pre-modification baseline emission, follow Rule 2005 provisions:
 1. Use daily mass limit, if available
 2. Use hourly mass limit multiplied by daily throughput limit, if available; if not, use 24 hours per day
 3. If no mass limit: use the most stringent of concentration limit or equivalent conc. from emission factor, multiplied by throughput limit, if available; if not, maximum throughput limit and 24 hours per day
 4. If no concentration limit: follow Rule 2005 max. hourly PTE (i.e. max. hourly mass emission rate within previous 12 months, prorated to max rated capacity) multiplied by throughput limit, if available; if not, multiply by maximum throughput limit and 24 hours per day

40

Permit Processing Fees

- Fees are proposed under Reg. III to recoup District costs to revise RECLAIM “facility permit”
 - Minimum Base Fee + Additional Time charges (if necessary)
 - 3 tiers – (<10, 10 -19, 20+) to allow better estimation of costs
- One fee for transitional permit including changes for Landing Rules fully compliant sources
- Future permit modification applications to be handled per normal permit processing procedures
- Option to convert “facility” to “equipment specific” permit available, but not encouraged (at this time)

41

Contacts

General RECLAIM Questions

- Gary Quinn, P.E.
Program Supervisor
909-396-3121
gquinn@aqmd.gov
- Kevin Orellana
Program Supervisor
909-396-3492
korellana@aqmd.gov

Proposed Amended Rules 1146, 1146.1, 1146.2 and Proposed Rule 1100

- Gary Quinn, P.E.
Program Supervisor
909-396-3121
gquinn@aqmd.gov
- Kalam Cheung
Program Supervisor
909-396-3281
kcheung@aqmd.gov

Proposed Rule 1109.1

- Heather Farr
Program Supervisor
909-396-3672
hfarr@aqmd.gov
- Jong Hoon Lee
Air Quality Specialist
909-396-3903
jhlee@aqmd.gov

42

Contacts

Proposed Rule 1118.1

- Heather Farr
Program Supervisor
909-396-3672
hfarr@aqmd.gov
- Steve Tsumura
Air Quality Specialist
909-396-2549
stsumura@aqmd.gov

Proposed Amended Rule 1135

- Michael Morris
Planning and Rules
Manager
909-396-3282
mmorris@aqmd.gov
- Uyen-Uyen Vo
Air Quality Specialist
909-396-2238
uvo@aqmd.gov

Proposed Amended Rule 1134

- Michael Morris
Planning and Rules
Manager
909-396-3282
mmorris@aqmd.gov
- Uyen-Uyen Vo
Air Quality Specialist
909-396-2238
uvo@aqmd.gov

43